

OWNER'S MANUAL

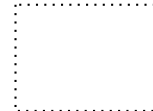
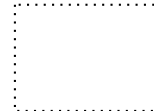
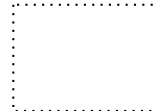

C a r A u d i o H i f i S y s t e m

PYLE[®] PLD182

DVD/VCD/CD/MP3 PLAYER

Contents

Safety Precautions.....	2	Play Operation.....	8
Electric Connection.....	3	Play/Pause	
Reception collection		Stop	
Speaker collection		Repeat	
		Random	
Installation.....	4	Radio Operation.....	9
Install the unit		Band	
Remove the unit		Band tuner	
General Features.....	5	Remote Control.....	10
Power		Loading and Replacing the battery	
Volume		Basic operation	
Eject			
Release			
Mode			
N/P			
Mute			
Clock			
EQ3			
Speaker setting.....	7	Specifications.....	18
Volume setting			
Bass setting			
Treble setting			
Balance setting			
Fader setting			
		Trouble Shooting.....	19

Safety precautions

▲ CAUTION

To prevent injury or fire, Please take the following precautions:

- Do not operate when driving.
- To prevent electric, etc, Please do not let the metal goods (silver, coin, tools...) fall into the installation.
- If you smell or see smoke, turn off the power immediately and consult our dealer.
- Be careful not to drop or shock the unit strongly.
- Do not touch the liquid crystal to avoid the life hurt. If the clothes are stained with it, please clean it immediately by soap.
- For your driving safety, please link your brake detecting wire with low power level, and keep it controlled by manual brake switch. When driving a car, the brake wire shall be high power level and now, unit can not play DVD or VCD disc.

▲ WARNING

To prevent damage to the machine, Attaching panel: take the following precautions:

- Be sure the unit is connected to a 12V DC power with a Negative Ground.
- Do not install the unit in places where it is exposed to direct sunlight, high heat or humidity, water splash or dust.
- To change fuse, please use the same one in specification and capacity.
- When changing fuse, please do it after pulling down power wires to avoid short circuit.
- If the unit seems not work in proper situation, please press the reset button to resume the function.

Attach the front panel by fixing the left side of it into this unit as 1 showing. Then push the right side of panel towards into connecting plug as 2 showing.

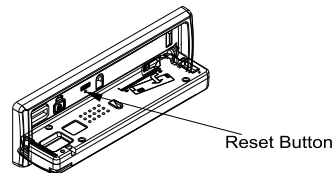
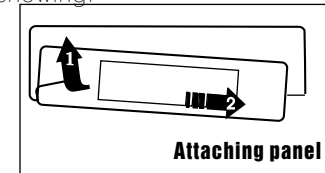

Electric Connection

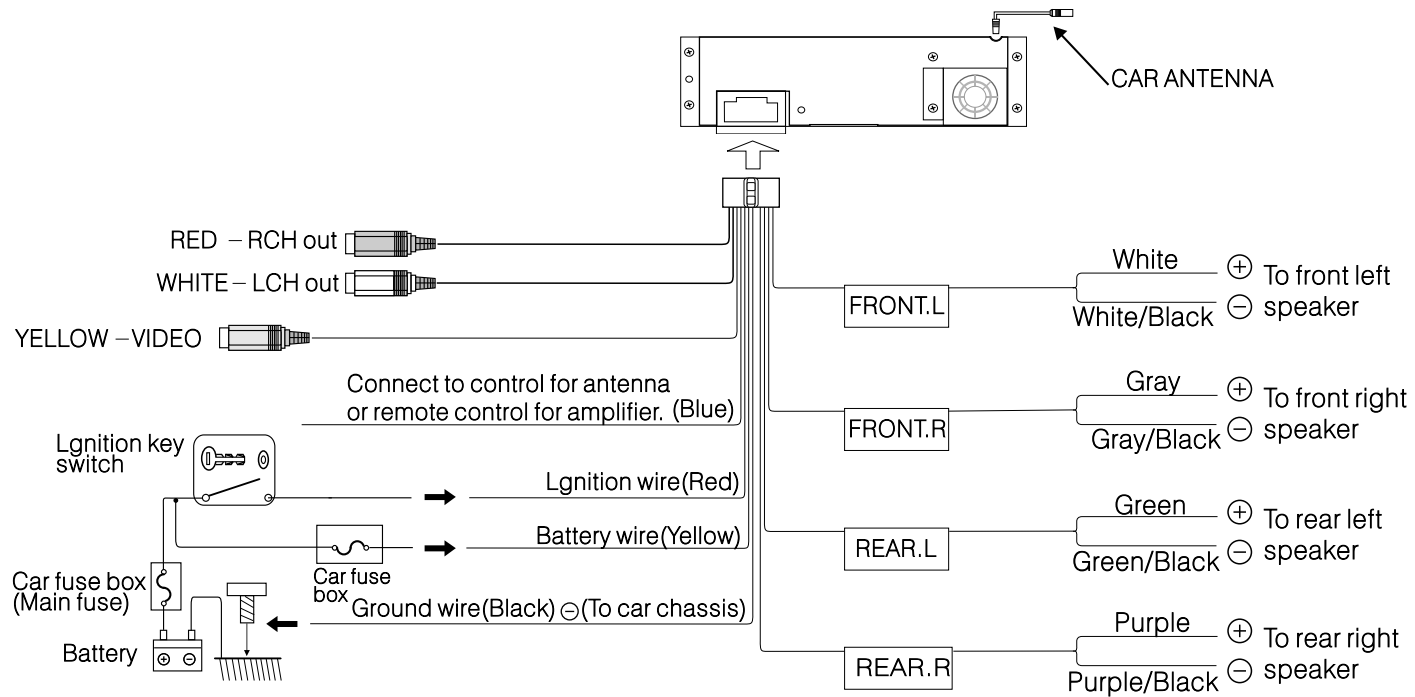

Installation

Before installing the receiver permanently, fit it in the approximate place in your car, and connect the equipment according to the speakers and electrical connections. When your system is operated properly, (preferably with the car engine running), follow the instructions for permanent installation of your system.

INSTALL THE UNIT

- 1) Install half sleeve, can be with or without adapter. It will fit better with adapter.
- 2) Bend over some tabs to secure the half sleeve inside of dash.
- 3) Support strap to be struted under dash, secure this strip to avoid skipping of disc.

REMOVE THE UNIT

- 1) Insert removal wrench into the small gap on the right side of the unit and pull the unit slightly out on the same side, then release the wrench. Repeat the same action for the left side. By now, you can remove the unit and unplug the wires connector.

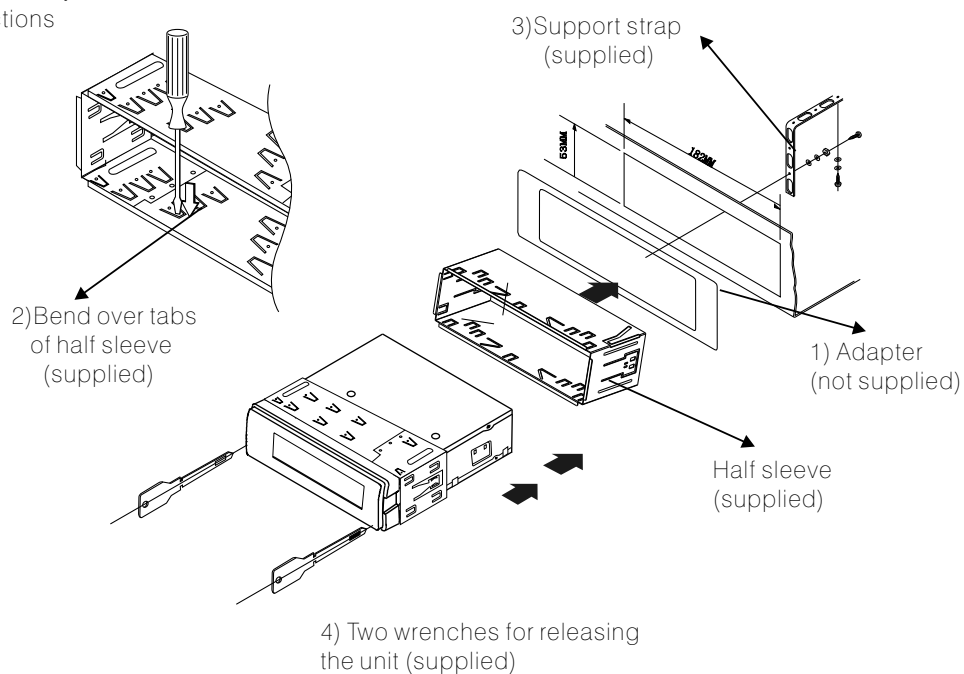

General Features

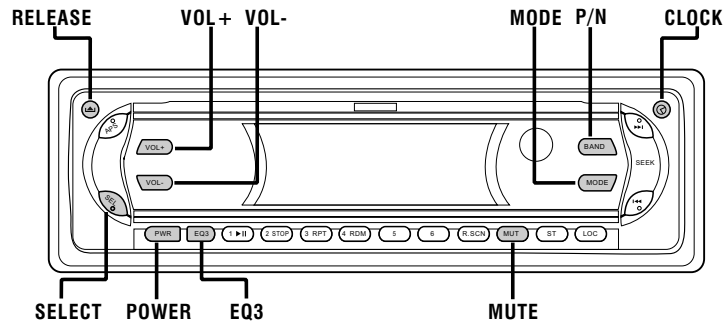

Power

Press the [PWR] button to turn on/off the unit.

Volume

Increasing volume

Press the VOL+ button in clockwise direction.



Decreasing

Press the VOL- button in anticlockwise direction.



Eject

Out

Press the [▲] button to eject the disc out of the unit .

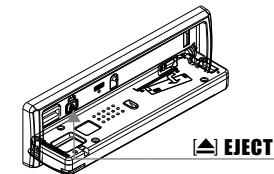

Release

press the " ▲ " button to release faceplate.

General Features

MODE

Selecting radio and play

 Each time you press the key, it will switch between radio position and disc position.

P/N

Press [BAND] button

 In video mode, press the [BAND] button to exchange between the PAL and NSTC.

Mute

 Short press this button to mute the sound, short press MUTE button again or press any other button to resume the normal listening.

Clock

Short press CLK can display time even power off.
Long Press CLK for 3 seconds will enter set mode.

Hour

Press the VOL +/- button to set the hour.

Minute

Press the VOL +/- button to set the minute.

Quit clock set mode

there is no operation in 5 seconds, it will quit clock set mode.

EQ3

 Press EQ3 button once to effect [ROCK] volume, LCD shows ROCK on.
Press EQ3 button twice to effect [POPS] volume, LCD shows CLASSICE on.
Press EQ3 button third to effect [CLASSIC] volume, LCD shows POP on.
Press EQ3 button fourth to effect [FLAT] volume, LCD shows FLAT on.
Press EQ3 button again to resume the normal listening.

Speaker setting

Speaker mode

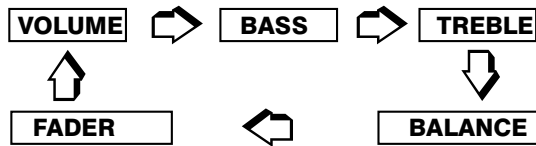

● Volume set mode

Press SEL button once, display shows VOL , then press the volume + button to adjust volume level up. press the volume - button to adjust volume level down.

VOL 10

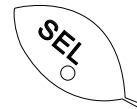

VOL+

VOL-

● Bass set mode

Press SEL button twice, display shows BAS , then press the volume + button to adjust bass level up. Press the volume - button to adjust bass level down.

BAS -6

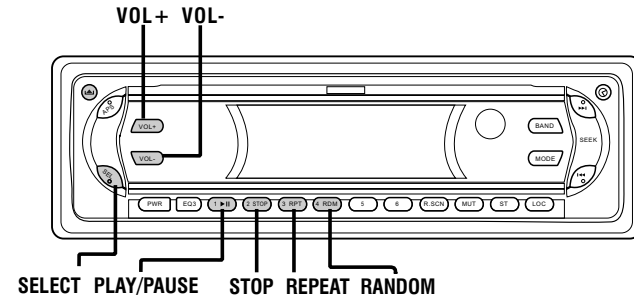

● Treble set mode

Press SEL button third, display shows TRE , then press the volume + button to adjust treble level up. Press the volume - button to adjust treble level down.

TRE 5

● Balance set mode

Press SEL button fourth, display shows BAL , then press the volume + button to adjust left speaks level . Press the volume - button to adjust right speaks level .

BAL 4

● Fader set mode

Press SEL button fifth, display shows FAD , then press the volume + button to adjust front speaks level. Press the volume - button to adjust back speaks level.

FAD -3

Play control

Play/pause

Play

If with DISC in unit, Press the  to pause music.



Pause

Press the  button again , come back DISC playing.

 If a disc is loaded, a sector sign will show on the display.



Stop

Press [STOP]button

 Press  button to stop music, and press  button to start playing from track one.

Repeat

Press [RPT]button

 Press the button  to repeat the same track continuously, RPT will appear on the LCD display.
Press the button again to come back normal playing.

Random

Press [RDM]button

 Press this button to play all the track in random order. Press it again to stop random playing. This button is invalid if the unit is in PBC On mode.

Radio Operation

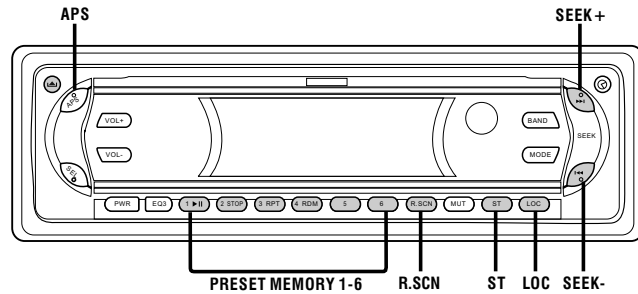

Band

Selecting band

Press BAND button to select among three FM or two AM bands.
(FM1-FM2-FM3-AM1-AM2)

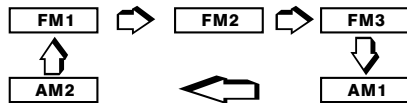

Loc

In radio mode, press this button to toggle between LOC/DX functions and LOC shown on the display indicates that LOC function is on.

- LOC is local frequency receipt
- DX is distance frequency receipt

Tuner

manual tuning:

- short press ►► button it can select higher frequency station.
- Short press ◄◄ can select lower frequency station.

Auto loading tuning:

- the long press ►► button it can automatically select higher frequency station. And the long press ◄◄ it can automatically select lower frequency station.

St

In FM band mode, press the ST key.

Each time you press the key, you switch between MONO position and stereo position

if the unit has received stereo signal in FM band in stereo position.

The LCD indicate **STEREO**. If the signal is MONO, it indicate ST only.

Select station

Press [APS] button

Seek Tune:

In FM (FM1 FM2 FM3) or AM (AM1 AM2) playing mode, long press "APS" button, it can seek and store strong frequency station automatically in to 1-6 memory buttons.

FM can be memorized 18 stations. AM can be memorized 12 stations.

Remote control



Loading and replacing the battery

Use one lithium battery(CR2025)
Insert the batteries with the + and - poles aligned properly.
Following the illustration inside the case.

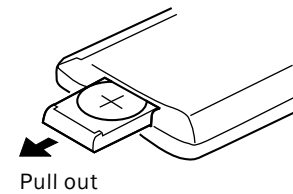

▲ WARNING

Store unused batteries out of the reach of children. Contact a doctor immediately if the battery is accidentally swallowed.

Do not set the remote on hot places such as the above dashboard.

Basic operation

POWER

Press this button to turn on/off the unit.

DSP

Press this button can show the time,and long press to enter clock adjustment.

MODE

Press this button can select needed receiving and playing mode.

EQ

Press this button can select mode as POPS,JAZZ,ROCK,DSP OFF.

SEEK+/SEEK-

Press this button can manually search tune,fast,back and track searching control.

SEL

Repeatfully press this button can select needed mode.

BAND P/N

Under receiving position,press this button can select band; under VCD,DVD position,press this button can select automatic,PAL or NTSC.

VOL+/VOL-

Press this button can increase or decrease volume.

LOC/RDM

Under receiving position,press this button can do far and close switch;under VCD,CD playing,press this button can play randomly.

■ Stop ▶|| Play/pause

■ Press this button to stop playing.

▶|| Press this button can switch between play and pause.Under stop state, similarly press it to play.

ST/PROG

Under receiving state,press this button can select stereo or single track;under playing state,it can do programme play cooperating with STOP button.

Basic operation

PBC

When playing VCD,OK disc,press this button can show all the programme menu,and can cooperate numeral buttons to select programmes.

[←] [→] [↑] [↓] [ENTER]

Under DVD mode, press this button can move cursor in up,down,left and right directions after entering SETUP Menu.Press ETR button can confirm selected item.

AMS/RPT

Under receiving state,press this button can scan memory stations.Long press it can automatically scan and store them.

SETUP

Under playing mode,press this button can open SETUP Menu.

ZOOM

Press this button can zoom picture.

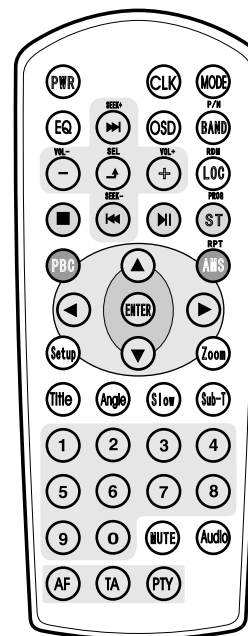

TITLE

Under VCD mode,press this button to enter Menu selection same as PBC.

Under DVD mode,press this button to return to the top of Menu.

Basic operation



ANGLE

Under DVD mode,press this button can change visual angle.

SLOW

Under VCD mode,press this button can advance slowly.

Under DVD mode,press this button can advance and back off slowly.

SUBTITLE 0-10+

Under DVD mode,press this button can switch dialogue language.

Press this button can directly select track and chapter,and 1-6 buttons can select presetted stations.

AUDIO

Under VCD mode,press this button can switch track.

Under DVD mode,press this button can switch dialogue language.

MUTE

Press this button to turn off volume out ,and again to resume.

OSD

Press this button can show play time, surplus time.

Basic operation

Setup Menu for Universal Capability

Press SETUP, screen will show system setup menu as follows:

- Press[▲] [▼] select Menu
- Press[◀] return to Menu
- Press[▶] Enter Menu
- Press[ENTER] to confirm

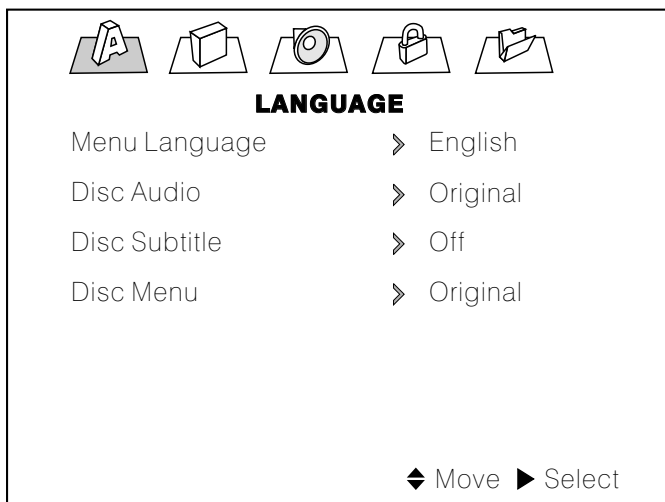

Display Setup Menu

- Press[▲] [▼] select Menu
- Press[◀] return to Menu
- Press[▶] Enter Menu
- Press[ENTER] to confirm

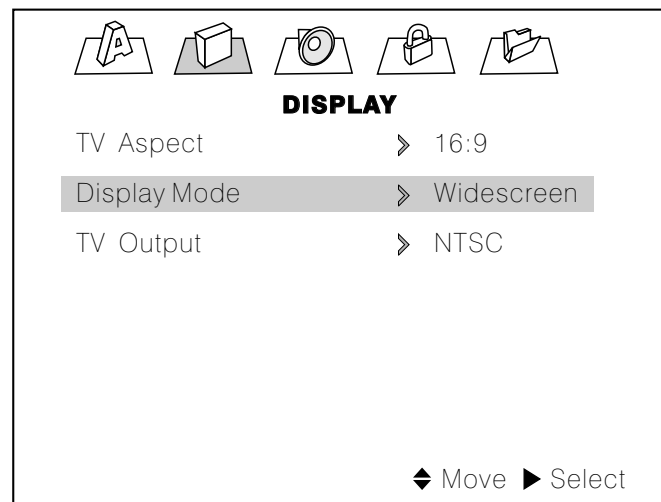

Basic operation

Audio Setup Menu

- Press[▲] [▼]select Menu
- Press[◀] return to Menu
- Press[▶] Enter Menu
- Press[ENTER] to confirm

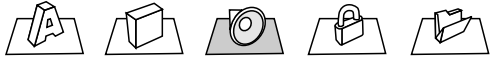

AUDIO

Dolby Digital	➤	Bitstream
DTS	➤	Bitstream
DRC	➤	On
Digital Output	➤	On

◆ Move ▶ Select

Lock Setup Menu

- Press[▲] [▼]select Menu
- Press[◀] return to Menu
- Press[▶] Enter Menu
- Press[ENTER] to confirm

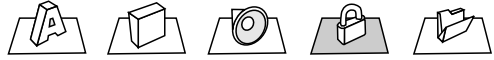

LOCK

Rating	➤	Unlock
Password	➤	New
Country	➤	U S

◆ Move ▶ Select

Basic operation

Others Setup Menu

- Press[▲][▼]select Menu
- Press[◀]return to Menu
- Press[▶]Enter Menu
- Press[ENTER]to confirm

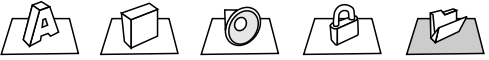

OTHERS

Load Default	➤ Select
Screen Saver	➤ On

◆ Move ▶ Select

Mp3 menu

Insert MP3 disc, and TV will show menu as follows:

Music

<div style="border-bottom: 1px solid black; padding-bottom: 5px;"> List </div> <table style="width: 100%; border-collapse: collapse;"> <tr><td style="border-bottom: 1px dashed black;">1-001</td><td style="border-bottom: 1px dashed black;">MP3</td><td style="border-bottom: 1px dashed black;">▶</td></tr> <tr><td style="border-bottom: 1px dashed black;">2-002</td><td style="border-bottom: 1px dashed black;">MP3</td><td style="border-bottom: 1px dashed black;">▶</td></tr> <tr><td style="border-bottom: 1px dashed black;">3-004</td><td style="border-bottom: 1px dashed black;">MP3</td><td style="border-bottom: 1px dashed black;">▶</td></tr> <tr><td style="border-bottom: 1px dashed black;">XXXXX</td><td style="border-bottom: 1px dashed black;">XXX</td><td style="border-bottom: 1px dashed black;">▶</td></tr> <tr><td style="border-bottom: 1px dashed black;">XXXXX</td><td style="border-bottom: 1px dashed black;">XXX</td><td style="border-bottom: 1px dashed black;">▶</td></tr> <tr><td style="border-bottom: 1px dashed black;">XXXXX</td><td style="border-bottom: 1px dashed black;">XXX</td><td style="border-bottom: 1px dashed black;">▶</td></tr> </table>	1-001	MP3	▶	2-002	MP3	▶	3-004	MP3	▶	XXXXX	XXX	▶	XXXXX	XXX	▶	XXXXX	XXX	▶	<div style="border-bottom: 1px solid black; padding-bottom: 5px;"> Program </div> <table style="width: 100%; border-collapse: collapse;"> <tr><td style="border-bottom: 1px solid black;"> </td></tr> <tr><td style="border-bottom: 1px solid black;"> </td></tr> <tr><td style="border-bottom: 1px solid black;"> </td></tr> <tr><td style="border-bottom: 1px solid black;"> </td></tr> <tr><td style="border-bottom: 1px solid black;"> </td></tr> <tr><td style="border-bottom: 1px solid black;"> </td></tr> </table>						
1-001	MP3	▶																							
2-002	MP3	▶																							
3-004	MP3	▶																							
XXXXX	XXX	▶																							
XXXXX	XXX	▶																							
XXXXX	XXX	▶																							
▶ 0:01:44 #2/135																									
\001 _____MP3																									

In this menu, the right is the submenu of the left, and it can cooperate remote control [Left][Right][Up][Down] buttons to select wanted contents and programmes and press ENTER to confirm.

Accessories

External view

..... Number of items

①



.....1

External view

..... Number of items

②



.....1

③



.....2



The use of any accessories except of those provided might result in damage to the unit .Make sure only to use the accessories shipped with the unit ,as shown above.

Specifications

Specifications subject to change without notice.

CD PLAYER

Signal/Noise ratio.....70dB
Frequency response.....20Hz-20KHz(+3dB)
Channel separation.....>45dB
Dual D/A converter.....16Bit

FM Tuner

Tuning range.....EUROPE:87.5-108.0MHz
(50KHz step)
USA:87.5-108MHz
(100KHz step)

FM usable sensitivity(S/N=30dB).....<12dB
Stereo separation.....>45dB

AM Tuner

Tuning range.....EUROPE:522-1620KHz
(9KHz step)
USA:520-1720KHz
(10KHz step)

AM sensitivity.....28dB

GENERAL

Operating power.....12 Volts DC,negative
ground

%10THD output wiring.....Designed for using four
speakers only front and rear
channels cannot be combined
in use with 2speakers.

Load impedance.....compatible 4 to 8 ohm
speakers

Fuses.....10 amp

Dimensions.....178mm(L)x50mm(W)
x150mm(H)

Weight.....2.5Kgs

Trouble shooting guide

What might seem to be a malfunction in your unit may just be the result of slight misoperation or miswiring. Before calling service, first check the following table for possible problems.

?The power does not turn ON.

✓ The fuse has blown.

 Confirm whether the lead short circuit, then replace fuse with same capacity.

?NO Sound.

✓ The cable connect incorrectness.

 Exactitude connect of the cable.

?Noise on Radio or poor reception

✓ Antenna and Antenna Cable.

 Check antenna and antenna cable, the antenna base must be grounded and connected with good condition, replace antenna or antenna cable if needed.

?Noise on both Radio and CD

✓ Poor ground, dirty or corroded at the car Battery posts

 Check the black wire for proper grounding clean and tighten ground connection.

?No/Poor sound on one or more speakers

✓ Speakers or speaker wiring or volume, Balance and Fader setting

 Check the speaker wiring and test the speakers all in good condition check the setting of volume, Balance and Fader controls.

?CD sound skips

✓ Installation the unit angle is greater than 45°, or mounting is not fixed and the back strap is not secure.

 Adjust the unit with mounting angle less than 45° and make sure the unit is mounted securely and tighten with the back strap (supplied)

?Unit completely inoperative, no Light and Sound

✓ Incorrect wire connection, Power RED/YELLOW or Ground wire or Blown fuse

 Check the Red wire to +12 Volts with key Ignition switch, yellow wire to +12 Volts battery and black wire to ground. Check Fuse with red/yellow wire, or check the fuse block on your car.

OWNER'S MANUAL

Before installation and operating the unit please read
this manual thoroughly and retain
it for future reference